

CONTACT
CONFIGURATION
(MP FACE VIEW)

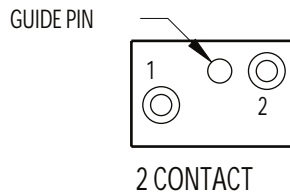

MOUNTING TORQUE FOR LPBH-FS/MP	not to exceed 100 in/lbs
MATED PRESSURE RATING (psi)	10,000
DUMMY PLUG FOR LPBH-2-FS, LPIL-2-FS	LPDC-2-MP
DUMMY PLUG FOR LPBH-2-MP, LPIL-2-MP	LPDC-2-FS
NOTE: Bulkhead body available in stainless steel. Standard 1/2" thread length.	

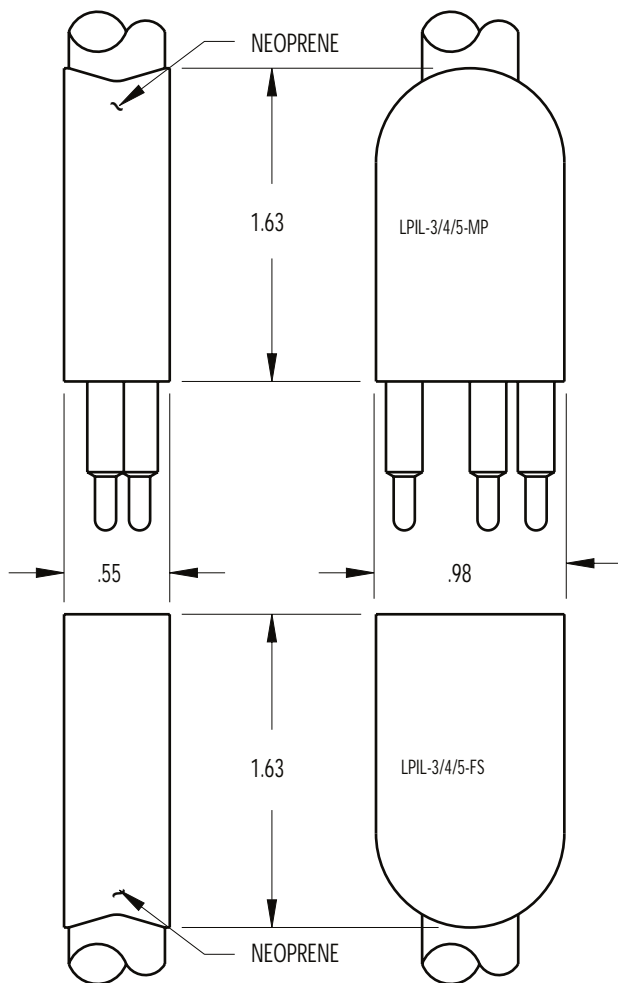
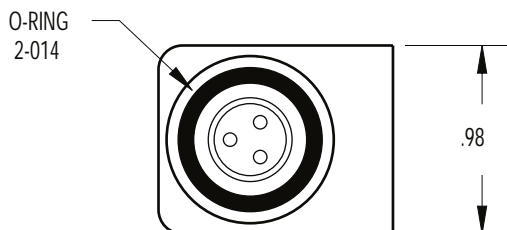
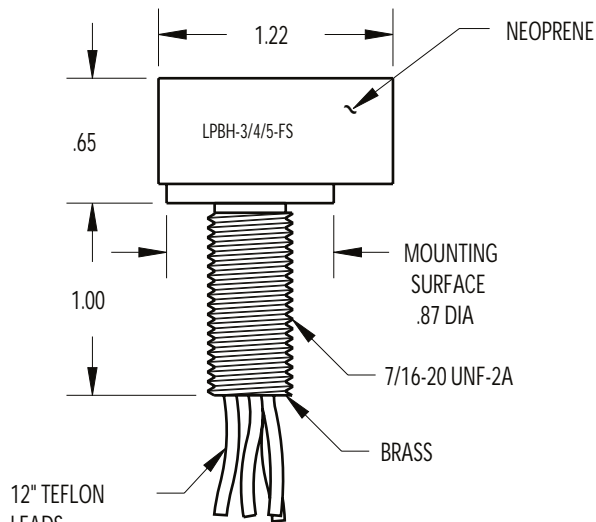
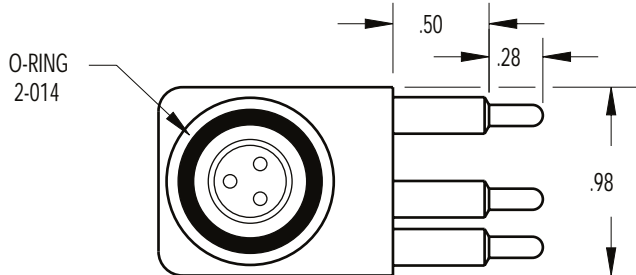
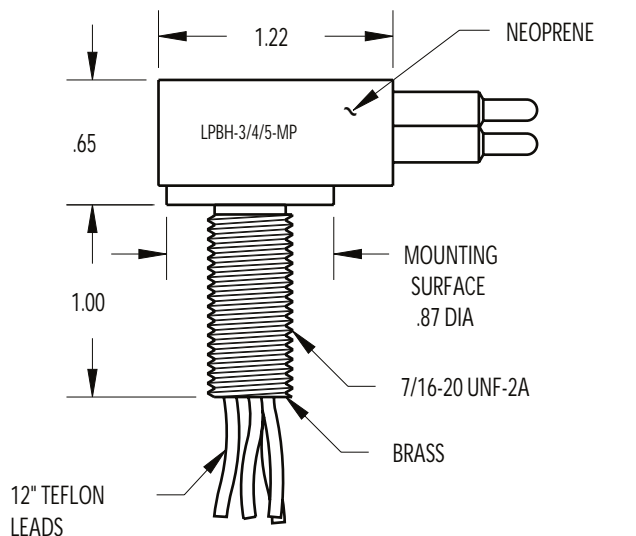

CONTACT
CONFIGURATION
(MP FACE VIEWS)

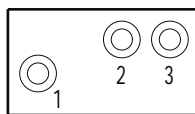

3 CONTACT

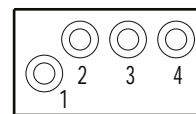

4 CONTACT

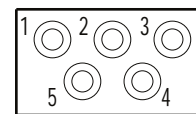

5 CONTACT

MOUNTING TORQUE FOR LPBH-FS/MP	not to exceed 100 in/lbs
MATED PRESSURE RATING (psi)	10,000
DUMMY PLUG FOR LPBH-3/4/5-FS, LPIL-3/4/5-FS	LPDC-3/4/5-MP
DUMMY PLUG FOR LPBH-3/4/5-MP, LPIL-3/4/5-MP	LPDC-3/4/5-FS
NOTE: Bulkhead body available in stainless steel. Standard 1" thread length.	

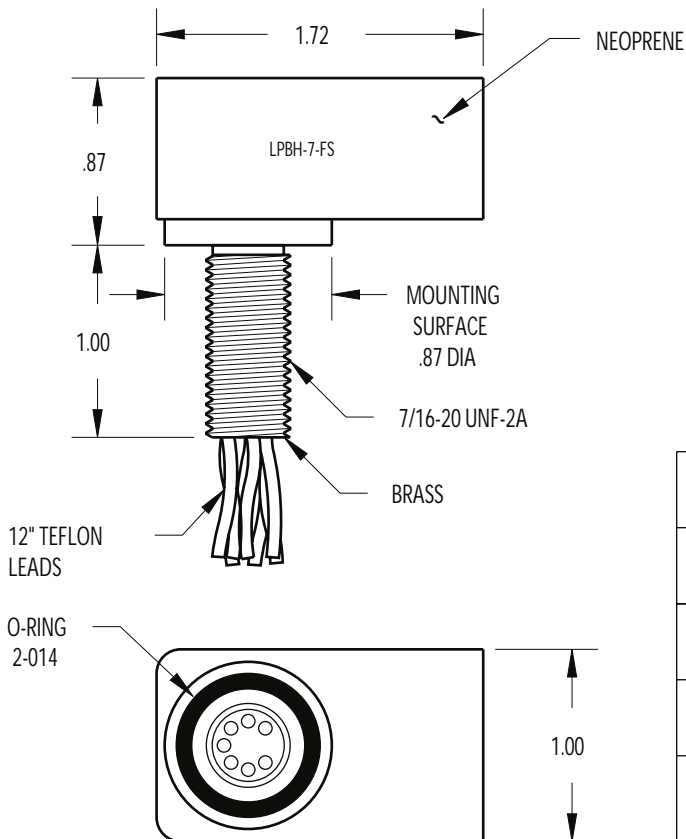
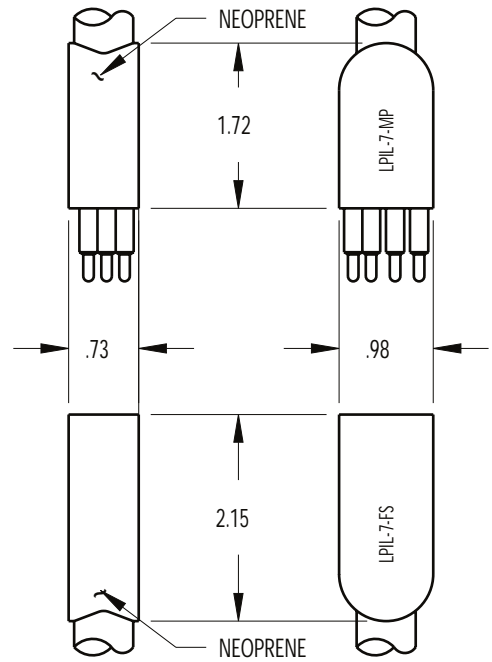
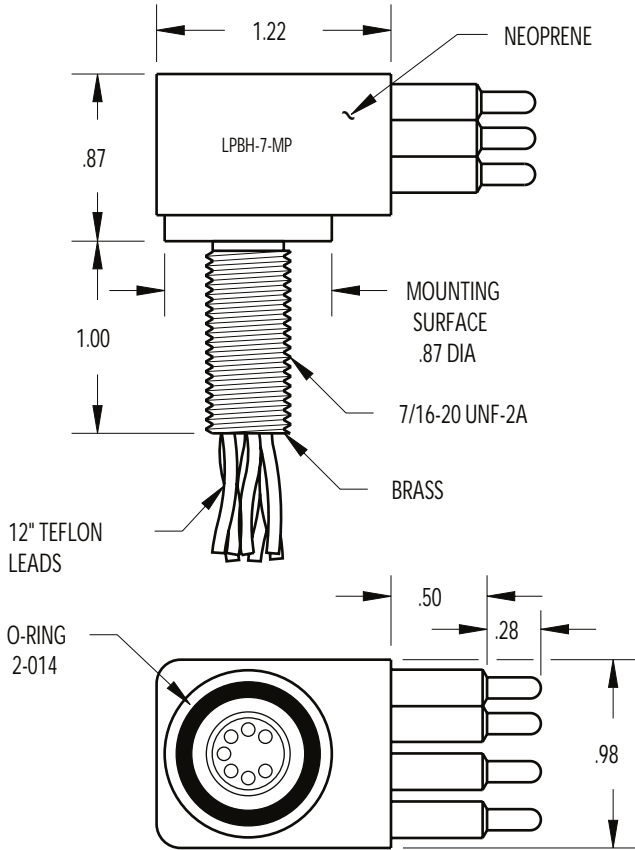

CONTACT
CONFIGURATION
(MP FACE VIEW)

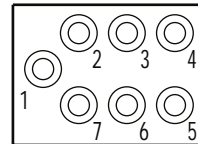

7 CONTACT

MOUNTING TORQUE FOR LPBH-FS/MP	not to exceed 100 in/lbs
MATED PRESSURE RATING (psi)	10,000
DUMMY PLUG FOR LPBH-7-FS, LPIL-7-FS	LPDC-7-MP
DUMMY PLUG FOR LPBH-7-MP, LPIL-7-MP	LPDC-7-FS
NOTE: Bulkhead body available in stainless steel. Standard 1" thread length.	

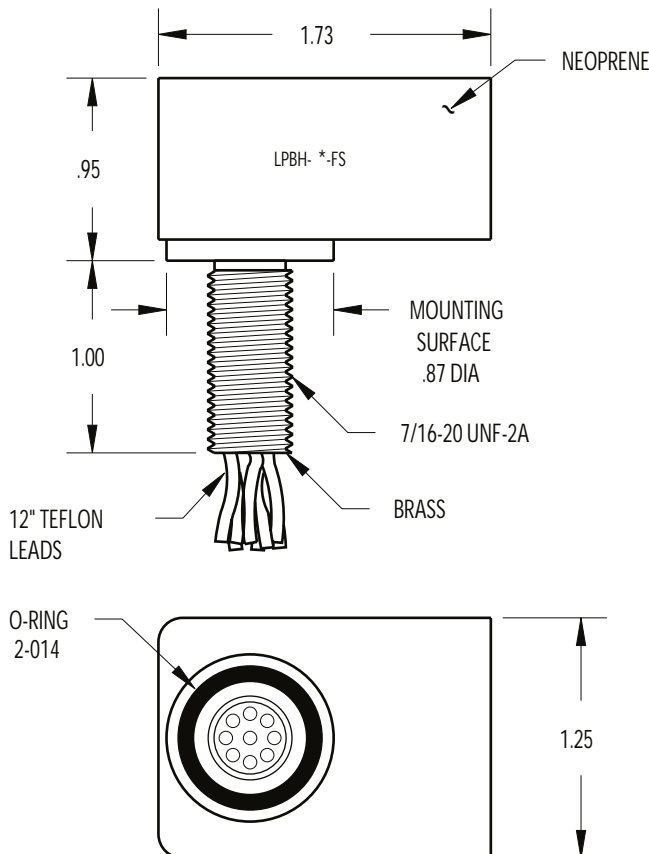
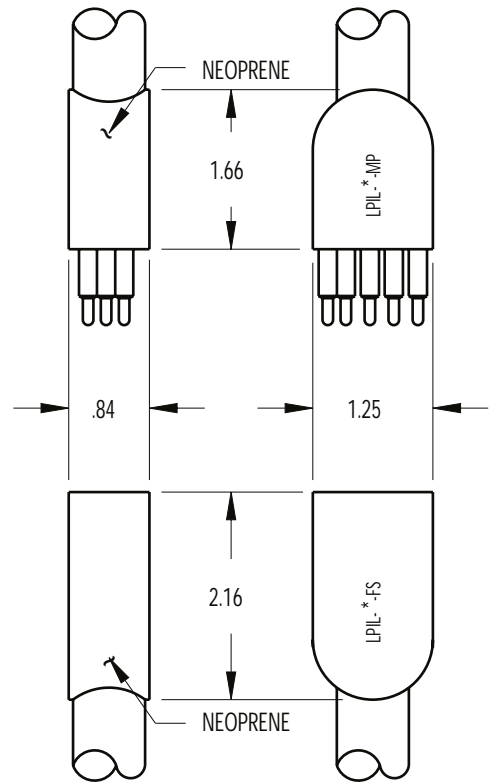
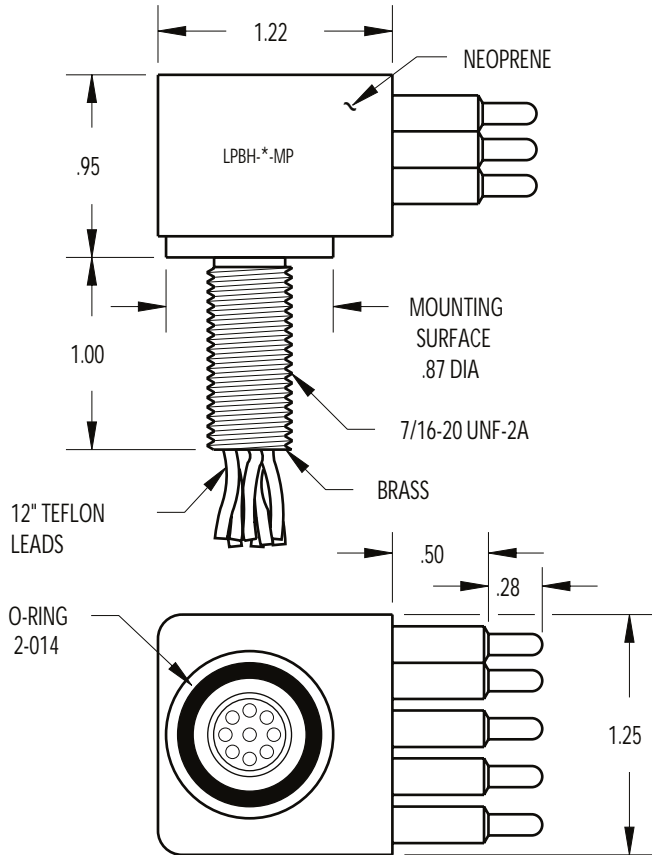

CONTACT
CONFIGURATION
(MP FACE VIEW)

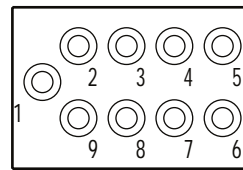

9 CONTACT

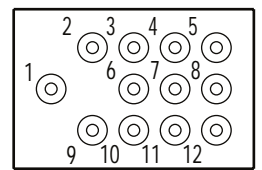

12 CONTACT

MOUNTING TORQUE FOR LPBH-FS/MP	not to exceed 100 in/lbs
MATED PRESSURE RATING (psi)	10,000
DUMMY PLUG FOR LPBH-9-FS, LPIL-9-FS	LPDC-9-MP
DUMMY PLUG FOR LPBH-9-MP, LPIL-9-MP	LPDC-9-FS
NOTE: Bulkhead body available in stainless steel. Standard 1" thread length.	